

HK1614-RS

Drawn cup needle roller bearing open end

Schaeffler ID:
0007000290968

Drawn cup needle roller bearings with open ends HK..-RS, lip seal on one side, to DIN 618

Technical information

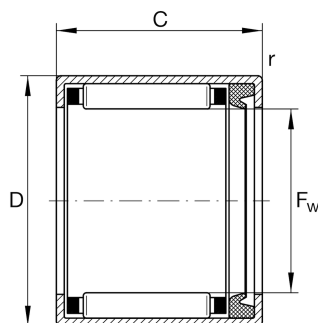

Main Dimensions & Performance Data

F_w	16 mm	Under roller diameter
D	22 mm	Outside diameter
C	14 mm	Width
C_r	7,600 N	Basic dynamic load rating, radial
C_{0r}	9,700 N	Basic static load rating, radial
C_{ur}	1,180 N	Fatigue load limit, radial
n_G	9,300 1/min	Limiting speed
$n_{G Grease}$	9,300 1/min	Limiting speed for grease lubrication
	12.87 g	Weight

Dimensions

C_1	14 mm	Width, outer ring
r_{min}	0.8 mm	Minimum chamfer dimension
	IR12X16X16-XL	Suitable inner rings IR

Temperature range

T_{min}	-20 °C	Operating temperature min.
T_{max}	100 °C	Operating temperature max.